



**EUROTHERM
DRIVES**

Profibus-DP Communications Interface

Technical Manual

HA463561U001 Issue 2

Compatible with Version 2.x Software

© Copyright Eurotherm Drives Limited 2002

All rights strictly reserved. No part of this document may be stored in a retrieval system, or transmitted in any form or by any means to persons not employed by a Eurotherm group company without written permission from Eurotherm Drives Ltd.

Although every effort has been taken to ensure the accuracy of this document it may be necessary, without notice, to make amendments or correct omissions. Eurotherm Drives cannot accept responsibility for damage, injury, or expenses resulting therefrom.

Safety Information



Please read this information **BEFORE** installing the equipment.

Intended Users

This manual is to be made available to all persons who are required to install, configure or service equipment described herein, or any other associated operation.

The information given is intended to highlight safety issues, and to enable the user to obtain maximum benefit from the equipment.

Application Area

The equipment described is intended for industrial motor speed control.

Personnel

Installation, operation and maintenance of the equipment should be carried out by qualified personnel. A qualified person is someone who is technically competent and familiar with all safety information and established safety practices; with the installation process, operation and maintenance of this equipment; and with all the hazards involved.

REFER TO YOUR MAIN PRODUCT MANUAL FOR SPECIFIC SAFETY INFORMATION ABOUT THE DEVICE YOU ARE CONTROLLING

Contents

Contents

Page

PROFIBUS-DP COMMUNICATIONS INTERFACE	1
A System Overview	1
The PROFIBUS Protocol	1
Principles of Operation.....	2
• I/O Data Exchange	2
Product Features	3
Product Code and Contents.....	3
Installation	4
Wiring the System	4
• Cable Specification.....	4
• Earthing the Shield	5
• User Connections to the Main Serial Port (P1).....	5
• Terminators.....	5
• Terminal Block (TB1) Connections.....	6
• Repeaters.....	6
Fitting and Connecting to the Technology Box	6
Connecting to the Technology Card (584SV only).....	7
• 584SV Types 4, 5 & 6.....	7
• 584SV Types 7, 8, 9 & 10	7
Wiring Diagram	8
Initial Check for Connection	8
Understanding the LED Indications	9
• Network and Module LED Indications.....	9
Initial Set-up for Profibus	10
Configuring the Drive.....	10
• The PROFIBUS DP MMI View (AC Drives).....	10
• The Non-specific ConfigEd-Lite & MMI View (AC Drives)	10
• The PROFIBUS DP MMI View (DC Drives)	11
• The Non-specific ConfigEd-Lite & MMI View (DC Drives).....	11
• Selecting PROFIBUS DP	11
Configuring the PLC/SCADA Supervisor.....	14
GSD Files	17
Configuration Data (Cfg_Data).....	17
Demand Data Protocol.....	20
Data Encoding	21
PROFIBUS Diagnostics	22
Troubleshooting	23
Internal Diagnostics.....	24
• INT DIAG SELECT Parameter Values	24
Decimal/Hexadecimal Table	25

PROFIBUS-DP COMMUNICATIONS INTERFACE

A System Overview

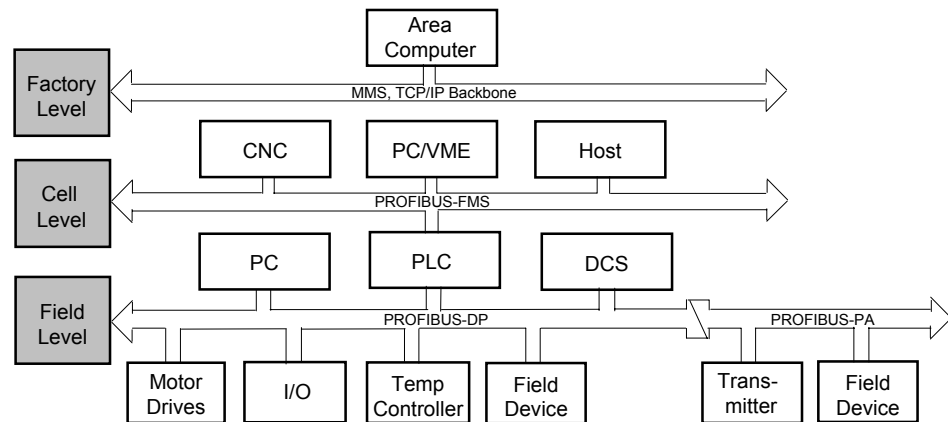

Figure 1 PROFIBUS Application Areas

The PROFIBUS Option supports the PROFIBUS-DP variant of the PROFIBUS protocol which is designed especially for communication between automatic control systems and distributed I/O at the device level. It is most often used to allow a central Programmable Logic Controller or PC based control system to use external 'slave' devices for I/O or specialised functions. The principal advantage is that these devices may be distributed around a machine, thereby saving on the cost of point to point wiring. The 'open' nature of the network also permits equipment from different manufacturers to be mixed on the same bus. Additionally, the off-loading of complex and specialised tasks such as PID temperature control lessens the processing load on the central PLC so that its other functions may be carried out more efficiently and require less CPU memory.

The PROFIBUS Protocol

PROFIBUS is a vendor independent, open fieldbus standard for a wide range of applications in manufacturing, process and building automation. Vendor independence and openness are guaranteed by the PROFIBUS standard EN50170. With PROFIBUS, devices from different manufacturers can inter-communicate. Suitable interfaces exist for PLCs, which include the Siemens, Mitsubishi and Allen Bradley range.

PROFIBUS-DP (De-central Periphery) is described in DIN 19245 Part 3, and forms part of EN 50170 with P-Net and WorldFIP. However it is important to note that P-Net and WorldFIP are *wholly incompatible* with PROFIBUS, using different wiring and transmission technologies.

The PROFIBUS-DP network uses a high speed version of the RS485 standard, permitting baud rates of up to 12Mbaud. A table of network speed against segment length is given in Chapter 3.

A maximum of 32 PROFIBUS-DP stations (nodes) may be contained within a single network segment. Use of RS485 repeaters allows a total of up to 126 stations.

PROFIBUS-DP is a multimaster, master-slave, token passing network. More detailed information, including a detailed guide to products available, may be obtained from the various world-wide PROFIBUS user organisations. You will find contact information in trade magazines or by reference to <http://www.profibus.com> on the World Wide Web.

PROFIBUS is available in two other types, aimed at different application areas, as follows:

1. **PROFIBUS-PA** is designed especially for process automation. It permits sensors and actuators to be connected on one common bus line even in intrinsically safe areas. PROFIBUS PA permits data communication and power over the bus, using intrinsically safe, 2-wire technology according to the international standard IEC 1158-2, but may also be used on the standard RS485 cabling for non-intrinsically safe applications.
2. **PROFIBUS-FMS** is the general purpose solution for communication tasks at the cell level.

Principles of Operation

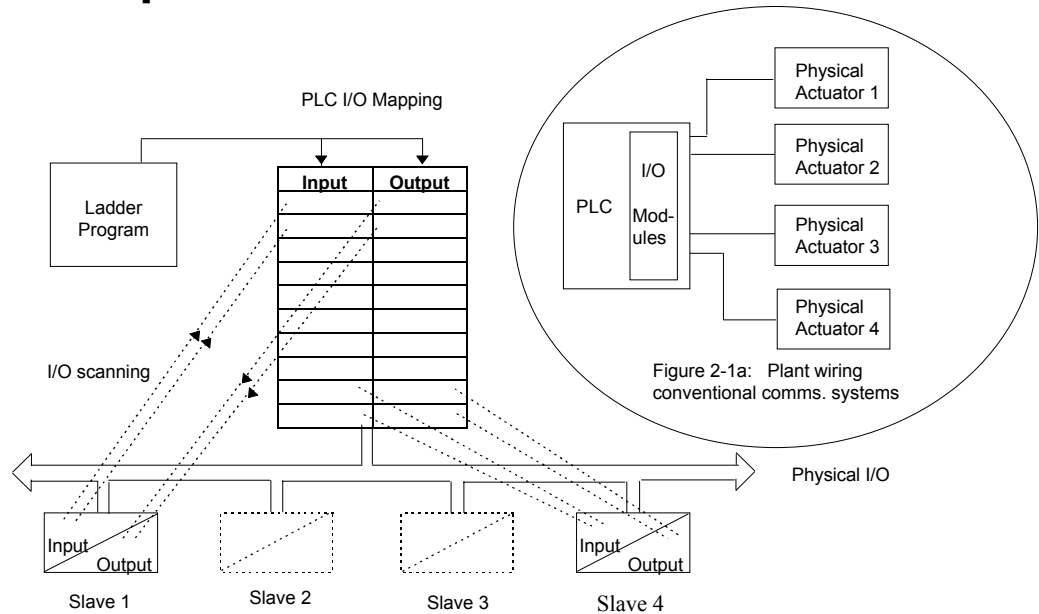

Figure 2 PROFIBUS compared with conventional comms. systems

PROFIBUS-DP distinguishes between master devices and slave devices. It allows slave devices to be connected on a single bus thus eliminating considerable plant wiring typical with conventional communications systems. The Figure above compares the two systems.

Master devices determine the data communication on the bus. A master can send messages without an external request when it holds the bus access rights (the token). Masters are also called active stations in the PROFIBUS protocol.

Slave devices are peripheral devices. Typical slave devices include input/output devices, valves, motor drives and measuring transmitters. The drives are intelligent slaves. This means they will only respond to a master when requested to do so.

PROFIBUS-DP is based around the idea of a 'cyclical scan' of devices on the network, during which 'input' and 'output' data for each device is exchanged.

I/O Data Exchange

The process of reading the inputs and writing to the outputs is known as an I/O data exchange. Typically, the parameters from each slave device will be mapped to an area of PLC input and output registers, or a single function block, so that the controlling ladder logic or program interfaces with the device as if it were an internally fitted module. It is NOT necessary, therefore, for the programmer to know anything about the physical network. The process of network configuration is usually performed using a PC based program which allows the devices on the network to be defined and device parameters to be mapped into the PLC registers or function blocks.

The cyclical scan occurs in the following order:

1. Values from each slave device, 'Input Data', are first scanned over the network into a pre-defined set of input registers in the master controller. Such values might be a set of digital input readings for a digital input unit, or the measured temperature and alarm status from a PID controller.
2. The master then runs its control program, (such as a ladder logic program) using the input data read from the slave devices.
3. The master writes output values (output data) into a pre-defined set of output registers. For example, one of the digital inputs read in the input data might be used to select one of a set of setpoints to be sent to the PID controller.
4. These outputs are then written to each slave device, and the scan-process-write cycle repeats.

Typically no more than 32 bytes of input data and 32 bytes of output data are exchanged for each device during the data exchange. Some PLC masters allow no more than this, although the

PROFIBUS-DP standard provides the possibility of transferring 236 bytes in each direction. The input and output data lengths for a given device are variable and it is possible to have devices with only input data, only output data, or both.

The input and output data mixture used by a given slave device is defined by what is known as a GSD file. See Chapter 5 for more details. For simple devices such as digital or analogue I/O blocks, this is fixed. However, since more complex devices often have a much wider choice of possible values to send, it is usually possible to edit the GSD file to change the mapping of device parameters onto Profibus inputs or outputs. This is the case with most Eurotherm implementations, which also allow access to parameter data not in the GSD Input/Output data file. This is called Demand Data and is described further in Chapter 7.

The GSD file is imported into the PROFIBUS Master Network Configuration software before the network is created.

NB: PROFIBUS Input Data = Values sent from a device to a master controller or PLC,
PROFIBUS Output Data = Values sent from a master controller or PLC to a device.

Product Features

- Suitable for use with:

584SV	software version 4.x onwards
590+	software version 5.x onwards
590+DRV	software version 5.x onwards
605A & B	software version 4.x onwards
605C	software version 4.x onwards
690+B	software version 1.x onwards
690+C,D,E,F,G,H,J	software version 1.x onwards

- Hardware self-test
- Connection using shielded, twisted-pair cable
- LEDs to indicate board and communications status
- Configured using Function Block inputs
- Diagnostics using Function Block outputs
- Automatic Baud Rate selection
- Software-selectable Slave Address
- Direct tag access for all drive parameters

Product Code and Contents

The Eurotherm Drives' product is fully identified using an alphanumeric code which records how the product was assembled, and its various settings when despatched from the factory.

The Technology Option can be supplied with the drive product, or supplied separately:

Product	Product Code when supplied with the Drive	Product Code when supplied separately
584SV	584SV /xxxx/xxx/xxxx/xx/xxx/ PROF /xx/xxx/xxx	AH463470U001 - plug-in Technology Card
590+	590P /xxxx/xxx/xxxx/xx/xxx/ PROF /xxx/xxx	6055/PROF/00 - plug-in Technology Box
590+DRV	955+ /x/x/xxxx/xxx	6055/PROF/00 - plug-in Technology Box
605A & B	605 /xxx/xxx/x/x/xxx 3 /xx/xxx	6053/PROF/00 - plug-in Technology Box
605C	605C /xxxx/xxx/xxxx/xx/xxx/ PROF /xx/xxx/xxx	6055/PROF/00 - plug-in Technology Box
690+B	690PB /xxxx/xxx/x/x/xxxx/xxxx/xxxx/ PROF /xxxx/xxxx/xxxx	6053/PROF/00 - plug-in Technology Box
690+C,D,E,F,G,H,J	690P /xxxx/xxxx/xx/xxx/ PROF /xxx/xxx/xx/xxx/xxx	6055/PROF/00 - plug-in Technology Box

4

Installation

Wiring the System

WARNING!

Before installing, ensure that the drive and all wiring is electrically isolated and cannot be made "live" unintentionally by other personnel.

Wait 5 minutes after disconnecting power before working on any part of the system or removing the covers from the Drive.

The Profibus Technology Option is provided in one of two forms:

1. A plug-in Technology Box
2. A board-mounted Technology Card (584SV only)

It is operated as a 2-wire system:

- A 2-wire system can only be used in a network in which all devices use their tri-state capability. Data flow is restricted, i.e. transmit and receive cannot be simultaneous (half duplex).

Note: *It is possible to make serial communications operate without adhering to the following recommendations, however, the recommendations will promote greater reliability.*

Cable Specification

Either of the two cable types detailed below can be used but we recommend Type A as it allows higher speed and longer cable length.

	Type A cable	Type B cable
Characteristic Impedance:	135 to 165Ω at a frequency of 3 to 20MHz.	135 to 165Ω at a frequency of > 100kHz
Cable capacitance:	< 30pF per metre	typically <60pF per metre
Core diameter:	max. 0.34 mm ² , corresponds to AWG 22	maximum 0.22mm ² , corresponds to AWG24
Cable type:	twisted pair cable. 1x2 or 2x2 or 1x4 lines	twisted pair cable. 1x2 or 2x2 or 1x4 lines
Resistance:	< 110Ω per km	-
Shielding:	Copper shielding braid or shielding braid and shielding foil	Copper shielding braid or shielding braid and shielding foil

Note: *Belden B3079A cable meets the above specification for Type A, but there are others.*

Maximum Line Length Per Segment

Baud rate (kbit/sec)	9.6	19.2	93.75	187.5	500	1500
Type A cable	1200m	1200m	1200m	1000m	400m	200m
Type B cable	1200m	1200m	1200m	600m	200m	-

Earthing the Shield

The PROFIBUS standard suggests that both ends of the transmission line should be connected to safety earth. If you do this, ensure that differences in local earth potential do not allow circulating currents to flow, as not only can these induce large common mode signals in the data lines, but they can also produce potentially dangerous heating in the cable. If in doubt, earth the shield at only one section of the network.

User Connections to the Main Serial Port (P1)

The serial port on the Option allows the following Profibus links to be made.

	Profibus
Electrical Connections	2-wire differential
Number of transmitters and transceivers allowed per differential pair of wires	32 transceivers
Maximum cable length	4000ft/1200 metres

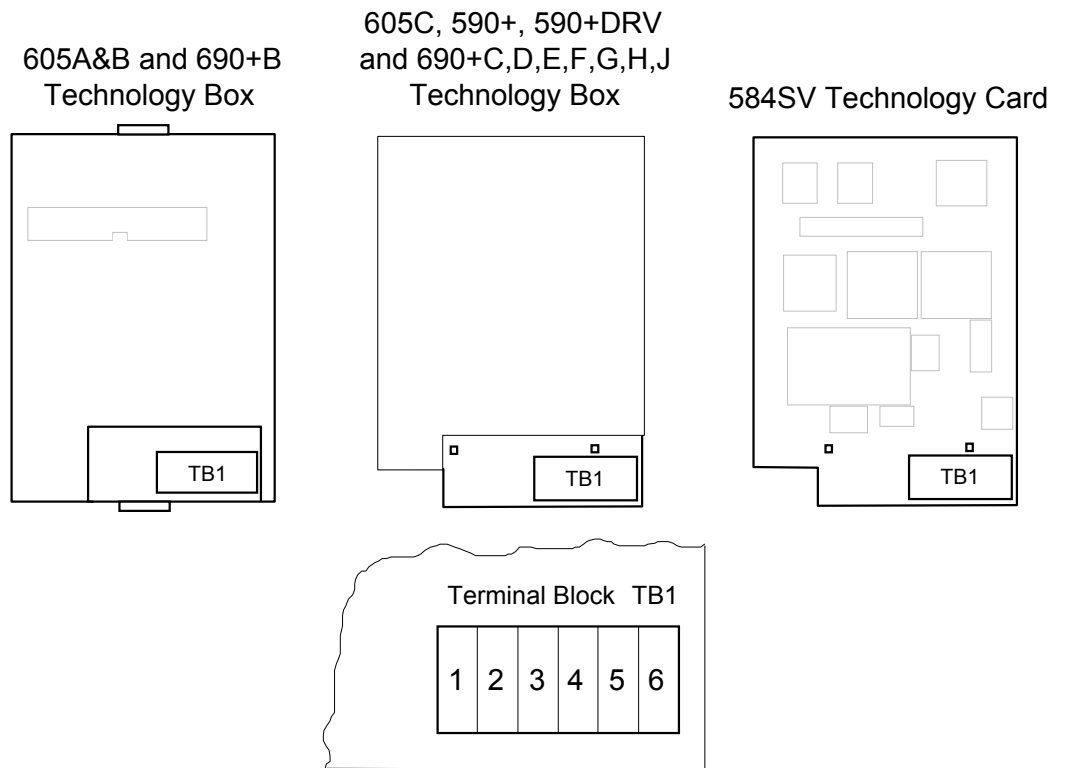
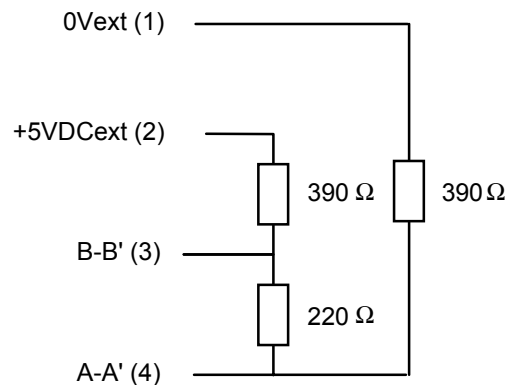

Figure 3 Option showing TB1

Terminators

- If the drive is at the end of the network it must have terminating resistors.
- All other drives in the system should not have terminators.

Connect terminating resistors to the last drive as shown opposite. (All resistors $\pm 5\%$, minimum $\frac{1}{4}$ Watt).



Terminal Block (TB1) Connections

TB1 Terminal	Reference	Meaning
1	0Vext	Signal reference for PROFIBUS
2	+5VDCext	+5VDCext/50mA supply for PROFIBUS
3	B-B'	Receive/Transmit Data Positive
4	A-A'	Receive/Transmit Data Negative
5	RTS	For connecting repeater (TTL)
6	GND	Ground connection for EMC

Repeaters

RTS (Pin 5 , TB1) is a TTL level signal that can be connected to a repeater. Most repeaters automatically switch between transmitting and receiving and so do not need this connection.

Fitting and Connecting to the Technology Box

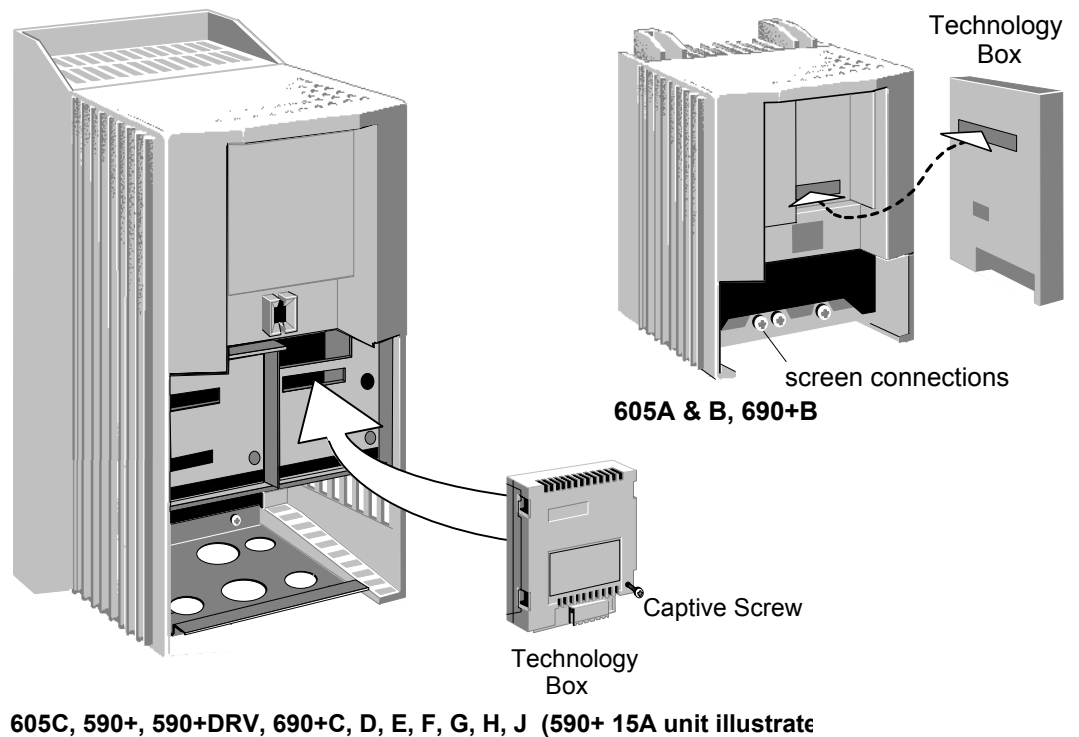

Figure 4 Plug-in Technology Boxes

WARNING!

Ensure that all wiring is isolated.

The Technology Option plugs into the right-hand position on the front of the drive, or in place of the Operator Station/blank cover (605A & B and 690+B only).

It can be used with the Operator Station fitted, but for the 605A & B and 690+B unit you must mount the Operator Station remotely using the Panel Mounting Kit with connecting lead (6052). The connecting lead enters the drive through the gland plate.

- Remove the terminal cover and screws.
- On the 605A & B and 690+B unit, plug the ribbon cable into the back of the Technology Box and into the socket on the drive.
- Click the Technology Box into place in the recess on the front of the drive. If provided, secure in position by tightening the captive screw on the bottom right hand corner of the Option.
- Make all user wiring connections. Refer to the Wiring Diagram.
- Re-fit the terminal cover securely with the screws.

Connecting to the Technology Card (584SV only)

The option is supplied as a “Technology Card”. This is factory-fitted to the control board inside the drive.



Static Sensitive

When connecting to the Technology Card, observe static control precautions.

WARNING!

Ensure that all wiring is isolated.

584SV Types 4, 5 & 6

- Remove the terminal cover and screws.

IMPORTANT: Remember to set the switch positions on the DIL switch, SW1.

- Make all user wiring connections. Refer to the Wiring Diagram.
- Re-fit the terminal cover securely with the screws.

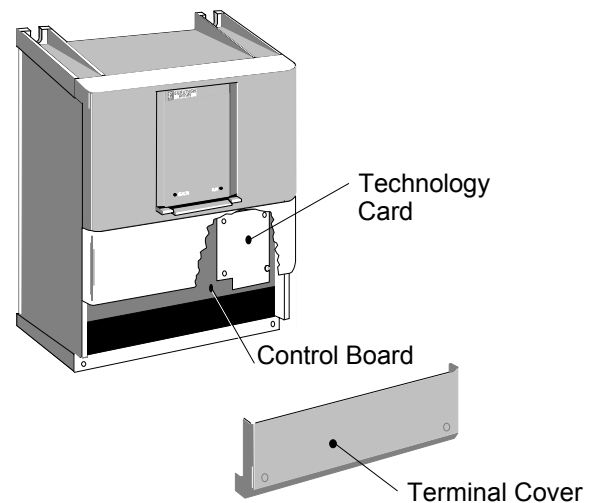

584SV Types 7, 8, 9 & 10

- Remove the bottom front cover.

IMPORTANT: Remember to set the switch positions on the DIL switch, SW1.

- Make all user wiring connections. Refer to the Wiring Diagram.
- Re-fit the terminal cover securely with the screws.

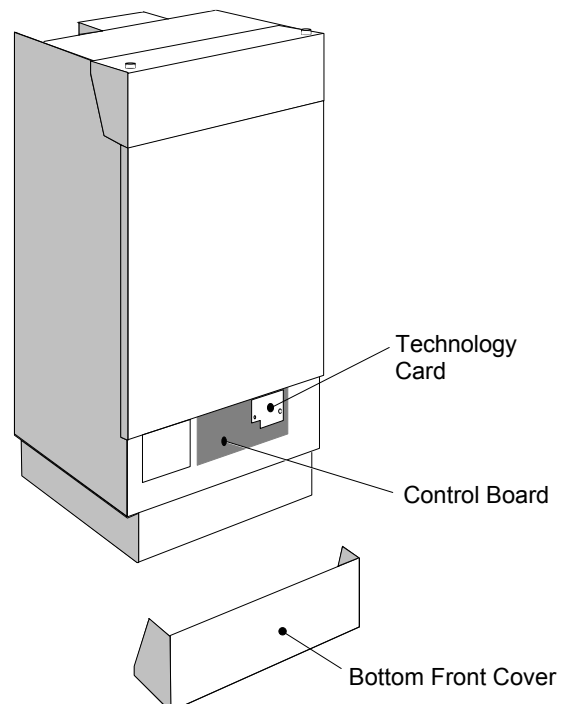

Wiring Diagram

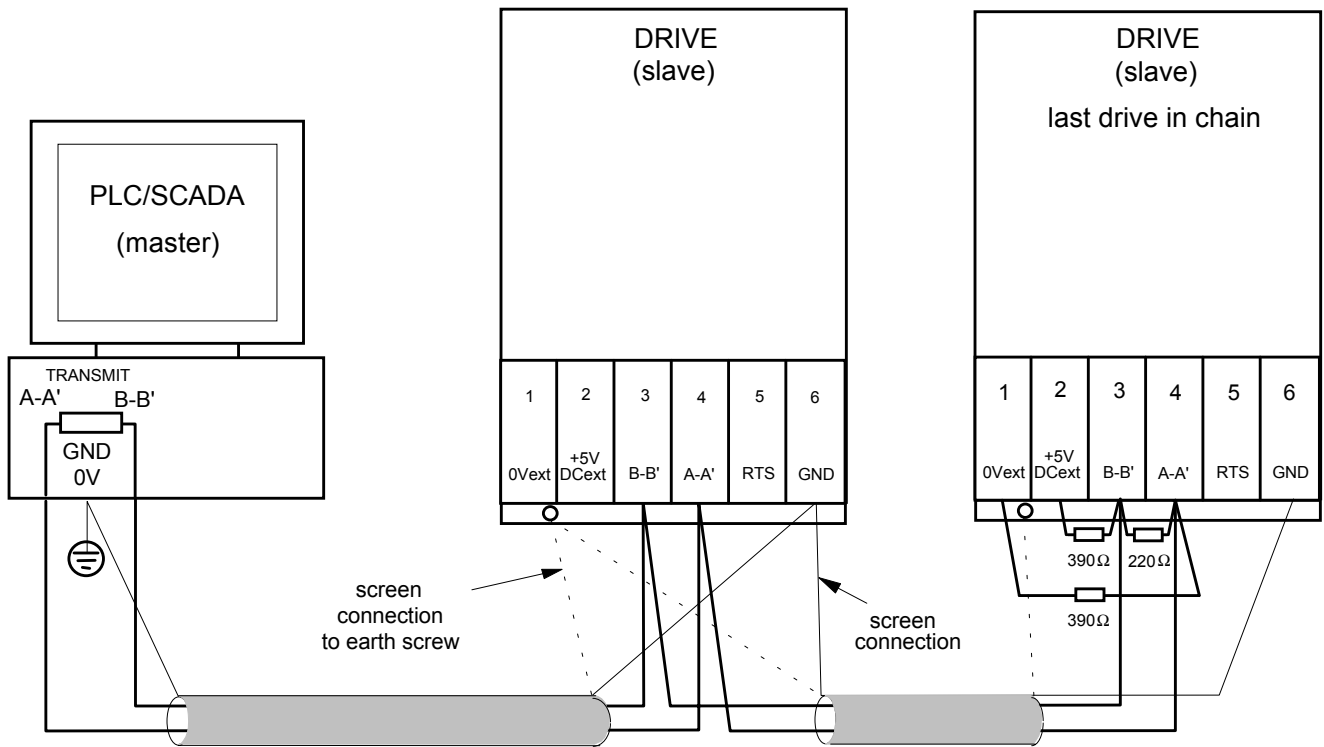

Figure 5 Typical Wiring Diagram

Note: The diagram above shows the terminal block orientation for the **BACK-VIEW** of the 605 A & B and 690+B Technology Box. When the Technology Box is in-situ, the terminal order is effectively reversed - **remember this when making user-connections**. Note that the screen connections for the 605A & B and 690+B terminate at an earthing pillar provided on the casing.

Initial Check for Connection

With the correct connections to the active PLC/SCADA supervisor, the MODULE LED will be ON continuously and the NETWORK LED will indicate the Idle state with a short flash.

ON		MODULE LED
SHORT FLASH		NETWORK LED

Understanding the LED Indications

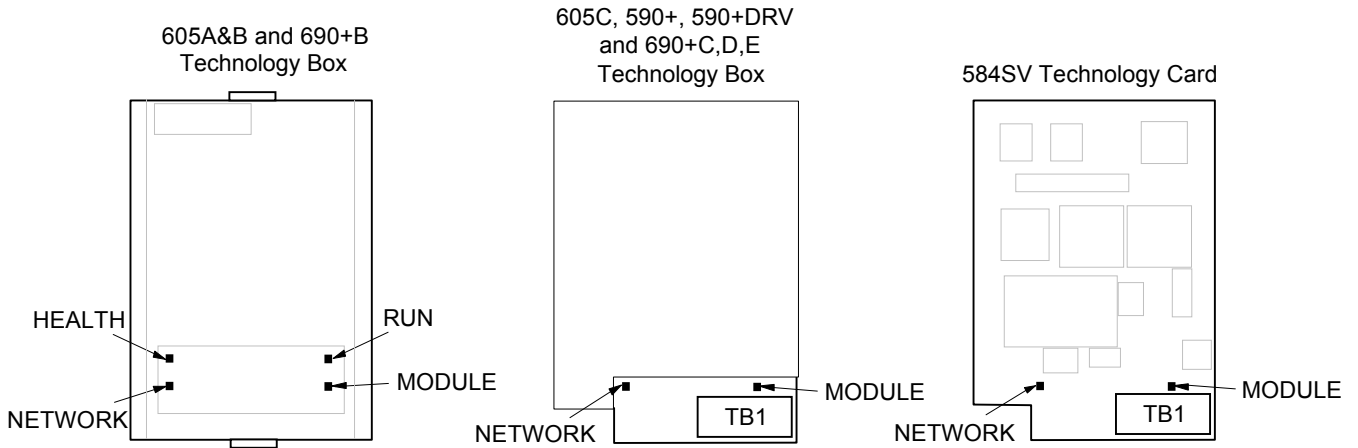

Figure 6 Technology Option LEDs

HINT:

The general rule for LED indications is
 “ON IS GOOD, OFF IS BAD”

Health and Run LEDs

605A & B and 690+B Technology Box

These LEDs reproduce the indications of the LEDs on the drive that are hidden by the fitting of the Technology Box.

584SV Technology Card & 605C, 590+, 590+DRV, 690+C,D,E,F,G,H,J Technology Box

The board does not have its own Health or Run LEDs. The LEDs are either on the Operator Station or blank cover.

Network and Module LED Indications

		Network LED	Module LED	
		Indicates the state of the connected network.	Indicates the set-up state of the Technology Box/Option. The states indicated are those produced by the FAULT parameter of the TEC OPTION function block.	
LED Indication		Description	FAULT Parameter	Description
OFF		Disabled or Baud search	HARDWARE	Hardware Fault - external
SHORT FLASH		Wait Parameterisation	SELF TEST	Hardware fault - internal
FLASH		Wait Configuration	TYPE MISMATCH	Wrong type or disabled
LONG FLASH		Data exchange with error	PARAMETER	Set-up fault, parameter values out-of-range
ON		Data exchange	NONE	Valid set-up, ready for external communications

Note: The NETWORK LED is always in the OFF state when the MODULE LED is *not* ON continuously, indicating that the Option is not ready for external communications.

Initial Set-up for Profibus

Configuring the Drive

Using the Operator Station (MMI) or other suitable PC programming tool, the TEC OPTION function block requires configuring before the PROFIBUS option can be used.

The parameter names/functions in this function block are inter-dependant and will change with different parameter values and the various Options that can be fitted.

When the PROFIBUS option is fitted and the TYPE parameter is set to display PROFIBUS, the function block parameters take on new identities, as shown in the two cases below.

ConfigEd-Lite is Eurotherm Drives' Windows-based block programming software.

The PROFIBUS DP MMI View (AC Drives)

With the PROFIBUS option correctly installed, the TEC OPTION function block will contain the following parameter names when viewed using the MMI.

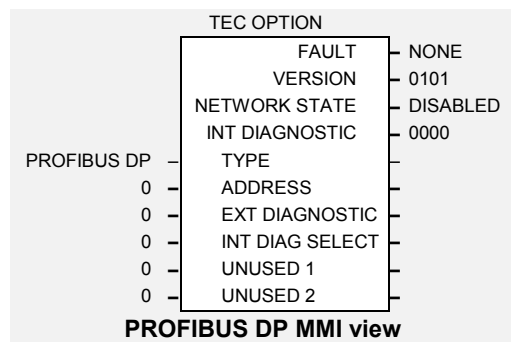

PROFIBUS DP MMI view

MMI Menu Map 584SV, 605A,B,C

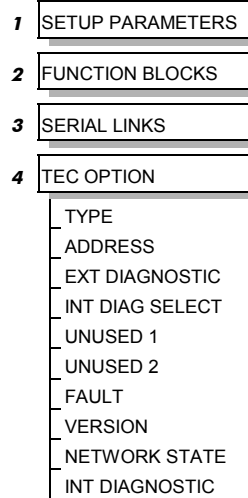

MMI Menu Map All 690+

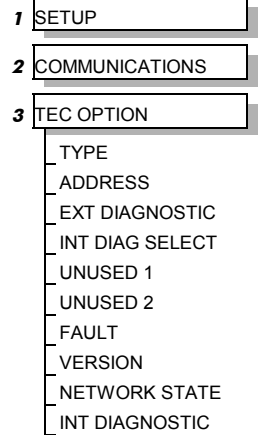

The Non-specific ConfigEd-Lite & MMI View (AC Drives)

This is how the TEC OPTION function block looks when viewed using ConfigEd-Lite.

The MMI also displays these non-specific parameter names when the PROFIBUS option is not yet installed into the drive, or an incorrect TYPE is selected for the fitted Option.

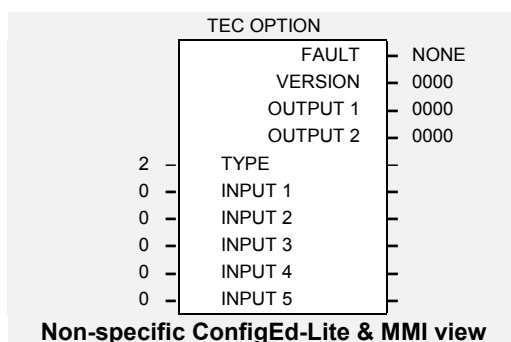

Non-specific ConfigEd-Lite & MMI view

MMI Menu Map 584SV, 605A,B,C

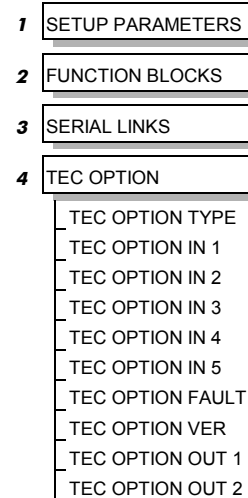

MMI Menu Map All 690+

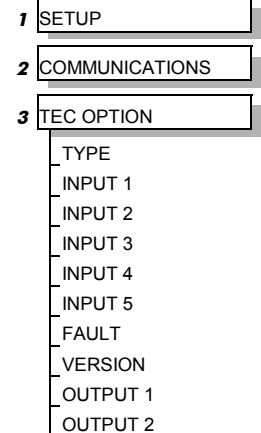

The PROFIBUS DP MMI View (DC Drives)

With the PROFIBUS option correctly installed, the TEC OPTION function block will contain the following parameter names when viewed using the MMI.

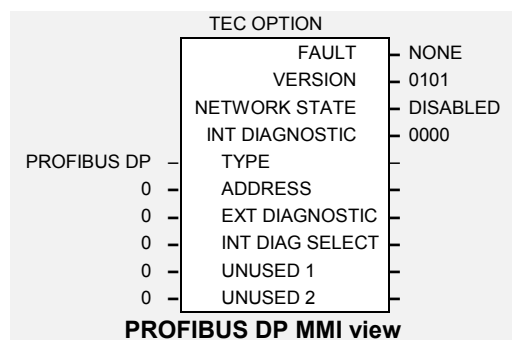

MMI Menu Map All 590+

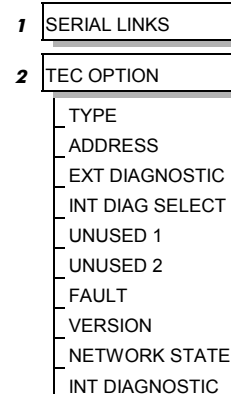

The Non-specific ConfigEd-Lite & MMI View (DC Drives)

This is how the TEC OPTION function block looks when viewed using ConfigEd-Lite.

The MMI also displays these non-specific parameter names when the PROFIBUS option is not yet installed into the drive, or an incorrect TYPE is selected for the fitted Option.

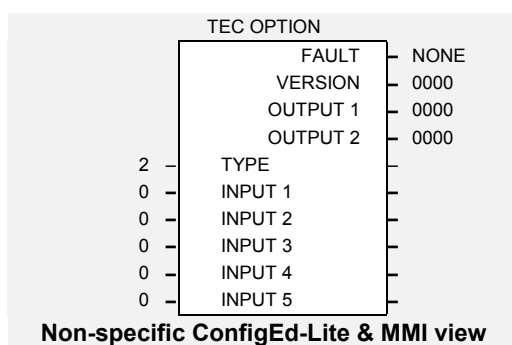

MMI Menu Map All 590+

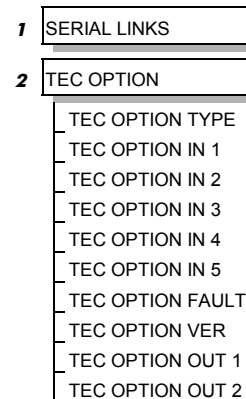

Selecting PROFIBUS DP

(Select Advanced view level on the Operator Station and view the TEC OPTION function block).

- Select PROFIBUS DP in the TYPE parameter
- Enter a slave ADDRESS
- Check the FAULT parameter for error messages, rectify if necessary

When setting values for parameters from ConfigEd Lite (or other suitable PC programming tool) you are able to select any value in the parameter's range, i.e. -32768 to 32767. If the value is incorrect, i.e. it doesn't correspond to a value that can be set using the MMI, then the FAULT output parameter will be set to PARAMETER.

MMI Parameter Descriptions

TYPE

Range: Enumerated - see below

Selects the type of Technology Option card.

Enumerated Value : Technology Option

0 : NONE

1 : RS485

2 : PROFIBUS DP

3 : LINK

4 : DEVICENET

5 : CANOPEN

6 : LONWORKS

7 : CONTROLNET

8 : MODBUS PLUS

9 : ETHERNET

ADDRESS

Range: 0 to 125

The PROFIBUS slave address. Note that addresses 0, 1 and 2 are usually reserved for PROFIBUS Masters and so should be avoided.

EXT DIAGNOSTIC

Range: 0 to FFFF

(External Diagnostic) The value of this parameter appears as the 2nd and 3rd bytes of the application specific diagnostics to the master. Refer to “PROFIBUS Diagnostics”, page 22. This provides a simple way to implement user defined trips or exceptions.

INT DIAG SELECT

Range: 0 to 29999

(Internal Diagnostic Select) Refer to “Internal Diagnostics”, page 24.

UNUSED 1

Range: 0 to FFFF

Reserved for future use.

UNUSED 2

Range: 0 to FFFF

Reserved for future use.

FAULT

Range: Enumerated - see below

The fault state of the Technology Option.

0 : NONE	no faults
1 : PARAMETER	parameter out-of-range
2 : TYPE MISMATCH	TYPE parameter not set to PROFIBUS DP
3 : SELF TEST	hardware fault - internal
4 : HARDWARE	hardware fault - external
5 : MISSING	no option fitted

Also refer to Network and Module LED Indications, page 9.

VERSION

Range: 0000 to FFFF

MMI Parameter Descriptions

The version of the Technology Option card. If no option is fitted then the version is reset to zero.

NETWORK STATE

Range: Enumerated - see below

The network state of the Technology Option card. Refer to “Network and Module LED Indications” page 9 for further information.

Enumerated Value : Fault State

0 : DATA EXCHANGE

1 : DATA EX ERROR

2 : WAIT CONFIG

3 : WAIT PARAM

4 : BAUD SEARCH

5 : DISABLED

DATA EXCHANGE

Data Exchange mode. The parameterisation and configuration have been accepted and the slave is exchanging user data with the master.

DATA EX ERROR

Data Exchange mode, as above, but with read/write error(s). This indicates that at least one of the parameters being read or written is failing, for example writing a value out of range.

WAIT CONFIG

Waiting for configuration. The parameterisation from the master has been accepted and is now waiting for the Master to send valid configuration data.

WAIT PARAM

Waiting for parameterisation. The slave has detected communications at a valid baud rate and is waiting for the master to send valid parameterisation data.

BAUD SEARCH

The slave has not detected valid communications.

DISABLED

The interface is disabled. The reason for this is given by the FAULT parameter.

INT DIAGNOSTIC

Range: 0000 to FFFF

Refer to “Internal Diagnostics”, page 24.

Configuring the PLC/SCADA Supervisor

Other than setting the TEC OPTION TYPE and ADDRESS within the Drive, as described earlier, all configuration is done via the Profibus-DP-Master.

During the start-up phase, the Profibus-DP-Master will check that the Profibus-DP-Slave at the requested address is of the required type. If it is, Configuration Data and User Parameter Data are downloaded.

The way the Profibus-DP-Master is configured depends on the manufacturer, but typically the following steps must be followed as shown in the following diagrams.

Note: The example uses Siemens COM PROFIBUS configuration tool.

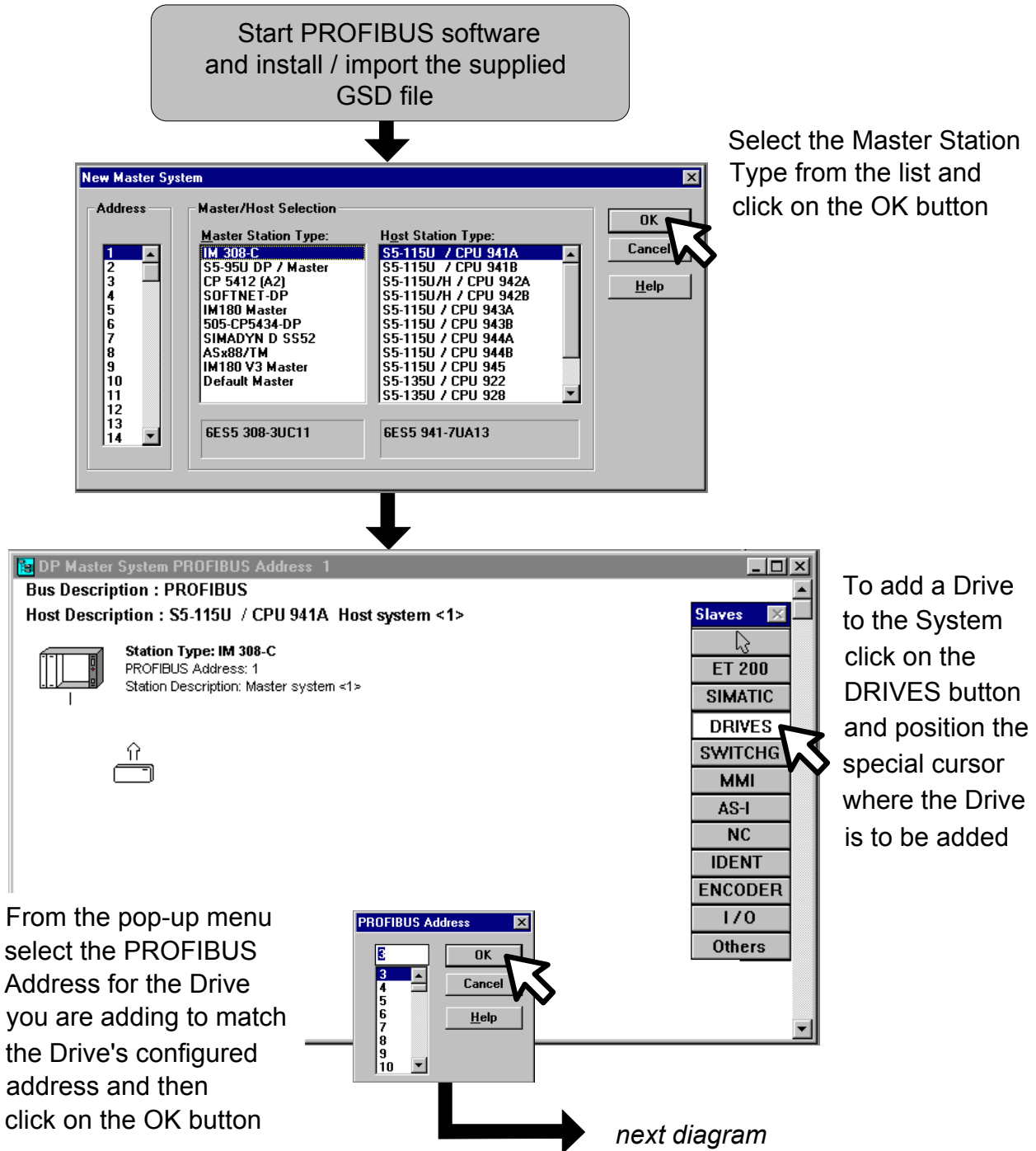
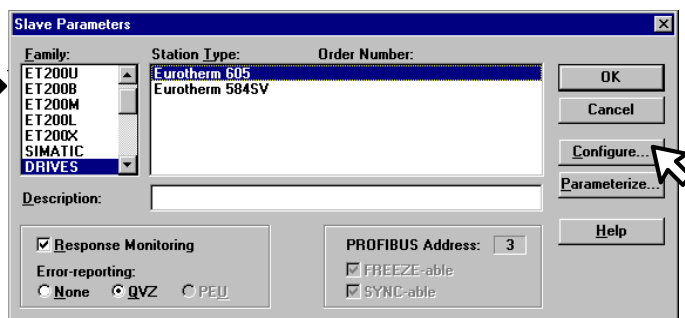
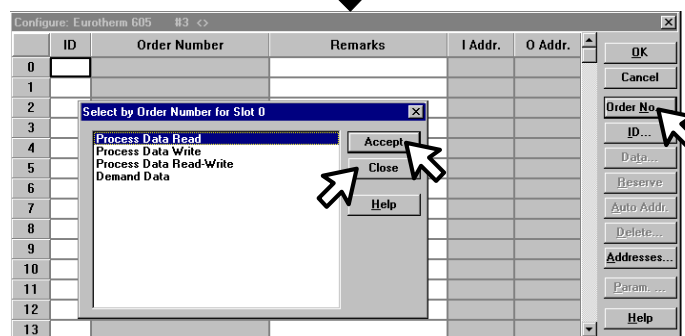

Figure 7 Typical Configuration Tool Procedure

continued →



With the 605 selection made as shown click on the Configure button



Click on the Order No. button to display the pop-up menu

Select from this list by clicking on Accept to make an entry in the Configure menu

Repeat this process until the list is complete and click on Close

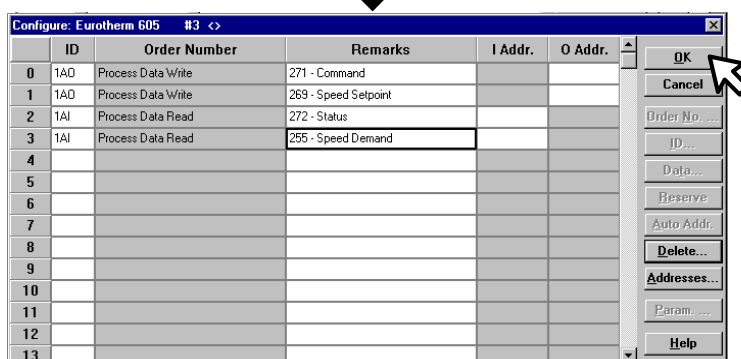

The ID column is now completed automatically (I Addr and O Addr. columns can also be set to do this)

Fill in the Remarks column for information and then click on the OK button



Click on the Parameterize button

→ next diagram

Figure 8 Typical Configuration Tool Procedure

To enable the Demand Data feature, the first byte of Cfg_Data is set to 0x73 (115 decimal). The number of Inputs and Outputs in the Process Data is defined by setting bytes to either 0x50 (80 decimal), 0x60 (96 decimal) or 0x70 (112 decimal). The maximum number of Process Data parameters is 30.

Index (No Demand Data)	Index (With Demand Data)	Identifier Byte (Hexadecimal)	Action
-	0	0x73	Enable Demand Data
0	1	0x50	Read 1st Parameter
		0x60	Write 1st Parameter
		0x70	Read/Write 1st Parameter
1	2	0x50	Read 2nd Parameter
		0x60	Write 2nd Parameter
		0x70	Read and Write 2nd Parameter
etc	etc	etc	etc
29	30	0x50	Read 30th Parameter
		0x60	Write 30th Parameter
		0x70	Read and Write 30th Parameter

For example:

Index	Data	Meaning
0	0x60	1st Parameter Output (No Demand Data)
1	0x60	2nd Parameter Output
2	0x50	3rd Parameter Input
3	0x50	4th Parameter Input

The supported Identifier Byte formats are defined by the Profibus Standard to have the following meaning:

Identifier	Input/Output	Length	Format	Consistency
0x50	Input	1	Word	None
0x60	Output	1	Word	None
0x70	Input-Output	1	Word	None
0x73	In and Out	4	Word	None

Note: All parameter values are transferred as Words (2 octets).

User Parameter Data (Usr_Prm_Data)

The Usr_Prm_Data is used to specify the Tag numbers of the parameters that are to be read or written as Process Data. Each parameter is represented by 2 bytes in the Usr_Prm_Data, these specify the Tag number in High-Byte/Low-Byte order.

The first 3 bytes of the Usr_Prm_Data are reserved for the future implementation on the DPV1 Profibus extensions. These must be set to zero. The High-Byte of the first Tag number must be in the 4th byte.

The Usr_Prm_Data may be up to 63 Bytes long. If less than 63 Bytes are sent, the length must be $3 \times 2n$, where n is a number between 0 and 30. Unused Bytes must be set to zero and must be at the end of the Tag declarations.

The number of Tags declared must match the number of Inputs, Outputs and Input-Outputs declared to be in the Process Data by the Cfg_Data.

Index	Data	Parameter
0	Reserved for DPV1	
1	Reserved for DPV1	
2	Reserved for DPV1	
3	High-Byte	1st
4	Low-Byte	
5	High-Byte	2nd
6	Low-Byte	
7	High-Byte	3rd
8	Low-Byte	
etc	etc	etc
61	High-Byte	30th
62	Low-Byte	

For example:

Index	Data (Hexadecimal)	Parameter
0	0x00	Reserved
1	0x00	
2	0x00	
3	0x01	Tag Number 271
4	0x0F	
5	0x01	Tag Number 269
6	0x0D	
7	0x01	Tag Number 272
8	0x10	
9	0x00	Tag Number 255
10	0xFF	

When entered using a Profibus configuration tool, the above example would typically be displayed as:

00, 00, 00, 01, 0F, 01, 0D, 01, 10, 00, FF

Some configuration tools will always display the number of bytes declared in the supplied GSD, in this case 63. So the above example will appear as:

00, 00, 00, 01, 0F, 01, 0D, 01, 10, 00, FF, 00, 00, 00, 00, 00, 00, 00, 00

Note: In addition to the standard tags, the 590+ PNOs 0 to 127 are mapped to tags 1000 to 1127.

Demand Data Protocol

Demand Data is a sub-protocol using the first 8 bytes (octets) in both the request and response message of the cyclic Data Exchange. It allows random read/write access to any parameter within the Drive. It is enabled by the Profibus-DP- Master setting the first byte of the Cfg_Data to 0x73. (See Chapter 6, Configuration.)

The sub-protocol consists of 3 parts:

- **Command**
- **Parameter Reference (Tag Number)**
- **Parameter Value or Error Code**

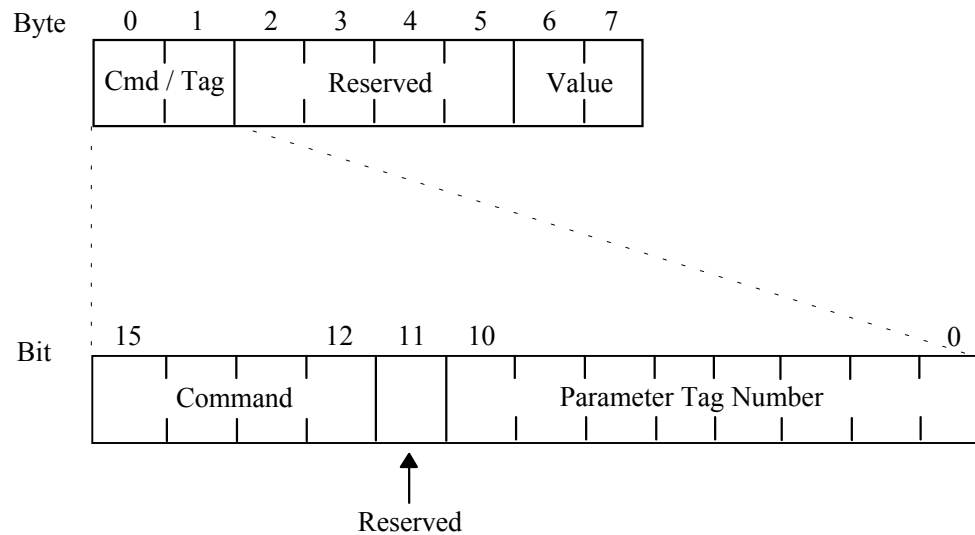

Command

The Command field in the request message selects the required operation. This is either None, Read or Write.

The Command field in the response message either confirms that no operation has been requested, indicates that a Read or Write request has been completed successfully or indicates that a Read or Write request has failed.

Valid values for the Command field are:

Command	Request (Master to Slave)	Response (Slave to Master)
0	No Command	Acknowledge No Command
1	Read Request	Acknowledge Transfer
2	Write Request	--
7	--	Reject Request

The valid Request/Response Command pairs are:

Request Command	Response Command
0	0
1	1 or 7
2	1 or 7

Parameter Reference (Tag Number)

The Parameter Tag Number is the unique reference to a parameter within the Drive. These are listed in the Product Manual.

Parameter Value or Error Code

The Value/Error Code field is used to receive a Read value, send a Write value or receive an error code.

The Value is a signed or unsigned 16-bit integer. The scaling for each parameter is described in the Product Manual for the host Drive.

If the Response Command is 7, i.e. the request has been rejected, this field contains the error code. These are:

Error Code	Meaning
0	Invalid Tag Number
1	Read Only Parameter
2	Value Under/Over-Range

Data Encoding

All parameter values are transferred in the Data Exchange telegram as Words (2 octets). The most significant octet is transmitted first, e.g.

Type	Value (decimal)	Transmitted Value (hexadecimal)
INT	300.00	7530
INT	-300.00	8AD0
BOOL	FALSE	0000
BOOL	TRUE	0001

Note: The decimal point position is not transmitted. Refer to the Product manual for the correct scaling.

PROFIBUS Diagnostics

Profibus DP provides diagnostic information for each slave unit. The Profibus Technology Option uses the 'ExtDiagData' of the diagnostic telegram (bytes 7, 8 and 9) to provide Trip status and user specified events. The Profibus master is notified whenever any of the monitored events change state. The documentation supplied with the master should provide details on how to access diagnostic information.

An example 605A & B diagnostic response telegram:

Octet 1	Octet 2	Octet 3	Octet 4	Octet 5	Octet 6	Octet 7	Octet 8	Octet 9	Octet 10
00	0C	00	01	16	49	04	01	6A	B5

Octet 7 signifies 4 bytes of information is included.

Octet 8 indicates a "Link Overvolts" Trip

Octets 9 and 10 indicate that the EXT DIAGNOSTIC parameter is set to 6AB5.

605A & B, 605C, 584SV, 690+B,C,D,E,F,G,H,J:

Octet 8, bits 0 to 4, contain the reason why the drive has tripped. (Bits 5 to 7 are reserved for future use.) The value contained in bits 0 to 4 have the following meaning:

0 = No Trip	9 = I*t
1 = Link Overvolts	10 = Brake Resistor
2 = Link Undervolts	11 = Brake Switch
3 = Link Overcurrent	12 = Operator Station
4 = Heatsink Temperature	13 = Lost Communications
5 = External Trip	17 = Motor Temperature
6 = Input 1 Break	18 = Current Limit
7 = Input 2 Break	20 = 24V Failure
8 = Motor Stalled	21 = Low Speed Current

Octets 9 and 10 are the most significant byte and least significant byte of the EXT DIAGNOSTIC input parameter of the TEC OPTION Function Block.

590+, 590+DRV:

The interface cannot distinguish the reason why the drive has tripped. The value contained in bits 0 to 4 have the following meaning:

0 = No Trip	31 = Tripped
-------------	--------------

Troubleshooting

NETWORK	MODULE	Cause/Symptom	Remedy
<input type="checkbox"/>	<input type="checkbox"/>	No power at the drive.	Check and apply power to the drive.
<input type="checkbox"/>	<input type="checkbox"/>	Technology Box/Option not installed correctly.	Check connections between Technology Box/Option and drive. On 605A & B, check the ribbon cable.
<input type="checkbox"/>	<input type="checkbox"/>	Hardware fault. 605A & B and 690+B WARNING: Remove the terminal cover and the Technology Box whilst connected to see the drive's HEALTH and RUN LEDs. BEWARE OF ELECTRIC SHOCK.	If HEALTH and RUN LEDs are OFF, replace the drive, else replace the Technology Box/Option.
<input type="checkbox"/>	<input checked="" type="checkbox"/>	The self-test has failed.	Replace the Technology Box/Option.
<input type="checkbox"/>	<input checked="" type="checkbox"/>	Incorrect Technology Box/Option fitted or selected.	Fit the correct Technology Box/Option or select the matching value for the TYPE parameter in the TEC OPTION function block. (TYPE = PROFIBUS DP).
<input type="checkbox"/>	<input checked="" type="checkbox"/>	Set-up fault. A TEC OPTION parameter is out-of-range.	Select the correct value for the parameter in the TEC OPTION function block.
<input type="checkbox"/>	<input checked="" type="checkbox"/>	No communications or intermittent failure	Check wiring, verifying the continuity of A and B connections to the master, and ensure that the correct terminals have been used. Pay particular attention to the integrity of the screening.
<input type="checkbox"/>	<input checked="" type="checkbox"/>	No communications or intermittent failure	Ensure that the maximum line length of transmission line has not been exceeded for the Baud rate in use. Refer to "Maximum Line Length Per Segment", page 4.
<input type="checkbox"/>	<input checked="" type="checkbox"/>	No communications or intermittent failure	Ensure that the last unit on the transmission line is terminated correctly. Note that some equipment has built-in resistors which may be switched in and out of circuit.
<input checked="" type="checkbox"/>	<input checked="" type="checkbox"/>	Waiting for valid Parameterisation data	Check the slave ADDRESS. Check that it is unique.
<input checked="" type="checkbox"/>	<input checked="" type="checkbox"/>	Waiting for valid Parameterisation data	Ensure that the network has been correctly configured and that the configuration has been correctly downloaded to the master.
<input checked="" type="checkbox"/>	<input checked="" type="checkbox"/>	Waiting for valid Parameterisation data	Verify that the GSD file being used is correct by loading it into the GSD file configurator to check the format.
<input checked="" type="checkbox"/>	<input checked="" type="checkbox"/>	Waiting for valid Configuration data	Refer to "Internal Diagnostics", page 24.
<input checked="" type="checkbox"/>	<input checked="" type="checkbox"/>	Read/Write failure	Refer to "Internal Diagnostics", page 24.
<input checked="" type="checkbox"/>	<input checked="" type="checkbox"/>	The unit should now be working.	If there is still a problem, please check your Tag numbers.

Internal Diagnostics

Two parameters of the TEC OPTION function block provide diagnostic information:

1. The NETWORK STATE parameter (and the Technology Option's LEDs) indicates the area the problem is in.
2. The INT DIAGNOSTIC parameter allows access to internal network diagnostic information. (The INT DIAG SELECT parameter selects what information will be output as the INT DIAGNOSTIC parameter).

INT DIAG SELECT Parameter Values	
0	Slave Configuration error. Used when stuck in the WAIT PARAM or WAIT CONFIG states.
	0000 No error.
	0012 Parameterisation telegram too long.
	0013 Parameterisation telegram is a bad length. If User_Prm_Data is present, it must be of length $3 + 2n$, where n is a value 0 to 30.
	0014 The list of tag numbers in the Usr-Prm_data contains a zero. Zero Tag numbers are only allowed at the end of the list.
	0021 The Configuration telegram is of zero length.
	0022 The Configuration telegram is too long. The maximum length is 31, i.e. configuration for 30 inputs, outputs or input-outputs, plus Demand Data.
	0023 The Configuration telegram contains an unsupported identifier byte. See Configuration Data section.
	0024 The Configuration telegram contains too few identifier bytes. Excluding the Demand Data identifier byte, if present, they must match the quantity of Tags declared in the Parameterisation telegram.
0025 The Configuration telegram contains too many identifier bytes. See above.	
100 to 129	Displays Tag number (in hexadecimal) of parameter 0 to 29, e.g. setting INT DIAG SELECT to 101 will show the Tag number of the 2nd parameter.
200 to 229	Displays access mode for parameter 0 to 29.
	0001 Input to master, i.e. read.
	0002 Output from master, i.e. write.
	0003 Input and output, i.e. both read and write.
300 to 329	Displays access error for parameter 0 to 29.
	0000 No error.
	0001 Data out of range. The value being written by the master is either less than the low limit or greater than the high limit for the specified parameter.
	0002 Read only. The master is attempting to write to a read-only parameter.
	0003 Not Stop mode. The master is attempting to write to a parameter which can only be updated when the drive is in the Stop mode, but it is in the Run mode.
	0004 Not Configuration mode. The master is attempting to write to a parameter which can only be updated when the drive is in the Configuration mode, but it is in the normal operating mode.
	0005 Unsupported type. The master is attempting to read or write a parameter of a type which is not supported by this implementation of the Profibus, i.e. type STRING.
	0006 Invalid Tag number. The master is attempting to read or write a parameter that does not exist.
400 to 429	Displays last read value (in hexadecimal) for parameter 0 to 29.
500 to 529	Displays last write value (in hexadecimal) for parameter 0 to 29. Note - 0000 if never written to by master.

Decimal/Hexadecimal Table

	0	1	2	3	4	5	6	7	8	9
0	0000	0001	0002	0003	0004	0005	0006	0007	0008	0009
10	000A	000B	000C	000D	000E	000F	0010	0011	0012	0013
20	0014	0015	0016	0017	0018	0019	001A	001B	001C	001D
30	001E	001F	0020	0021	0022	0023	0024	0025	0026	0027
40	0028	0029	002A	002B	002C	002D	002E	002F	0030	0031
50	0032	0033	0034	0035	0036	0037	0038	0039	003A	003B
60	003C	003D	003E	003F	0040	0041	0042	0043	0044	0045
70	0046	0047	0048	0049	004A	004B	004C	004D	004E	004F
80	0050	0051	0052	0053	0054	0055	0056	0057	0058	0059
90	005A	005B	005C	005D	005E	005F	0060	0061	0062	0063
100	0064	0065	0066	0067	0068	0069	006A	006B	006C	006D
110	006E	006F	0070	0071	0072	0073	0074	0075	0076	0077
120	0078	0079	007A	007B	007C	007D	007E	007F	0080	0081
130	0082	0083	0084	0085	0086	0087	0088	0089	008A	008B
140	008C	008D	008E	008F	0090	0091	0092	0093	0094	0095
150	0096	0097	0098	0099	009A	009B	009C	009D	009E	009F
160	00A0	00A1	00A2	00A3	00A4	00A5	00A6	00A7	00A8	00A9
170	00AA	00AB	00AC	00AD	00AE	00AF	00B0	00B1	00B2	00B3
180	00B4	00B5	00B6	00B7	00B8	00B9	00BA	00BB	00BC	00BD
190	00BE	00BF	00C0	00C1	00C2	00C3	00C4	00C5	00C6	00C7
200	00C8	00C9	00CA	00CB	00CC	00CD	00CE	00CF	00D0	00D1
210	00D2	00D3	00D4	00D5	00D6	00D7	00D8	00D9	00DA	00DB
220	00DC	00DD	00DE	00DF	00E0	00E1	00E2	00E3	00E4	00E5
230	00E6	00E7	00E8	00E9	00EA	00EB	00EC	00ED	00EE	00EF
240	00F0	00F1	00F2	00F3	00F4	00F5	00F6	00F7	00F8	00F9
250	00FA	00FB	00FC	00FD	00FE	00FF	0100	0101	0102	0103
260	0104	0105	0106	0107	0108	0109	010A	010B	010C	010D
270	010E	010F	0110	0111	0112	0113	0114	0115	0116	0117
280	0118	0119	011A	011B	011C	011D	011E	011F	0120	0121
290	0122	0123	0124	0125	0126	0127	0128	0129	012A	012B
300	012C	012D	012E	012F	0130	0131	0132	0133	0134	0135
310	0136	0137	0138	0139	013A	013B	013C	013D	013E	013F
320	0140	0141	0142	0143	0144	0145	0146	0147	0148	0149
330	014A	014B	014C	014D	014E	014F	0150	0151	0152	0153
340	0154	0155	0156	0157	0158	0159	015A	015B	015C	015D
350	015E	015F	0160	0161	0162	0163	0164	0165	0166	0167
360	0168	0169	016A	016B	016C	016D	016E	016F	0170	0171
370	0172	0173	0174	0175	0176	0177	0178	0179	017A	017B
380	017C	017D	017E	017F	0180	0181	0182	0183	0184	0185
390	0186	0187	0188	0189	018A	018B	018C	018D	018E	018F
400	0190	0191	0192	0193	0194	0195	0196	0197	0198	0199
410	019A	019B	019C	019D	019E	019F	01A0	01A1	01A2	01A3
420	01A4	01A5	01A6	01A7	01A8	01A9	01AA	01AB	01AC	01AD
430	01AE	01AF	01B0	01B1	01B2	01B3	01B4	01B5	01B6	01B7
440	01B8	01B9	01BA	01BB	01BC	01BD	01BE	01BF	01C0	01C1
450	01C2	01C3	01C4	01C5	01C6	01C7	01C8	01C9	01CA	01CB
460	01CC	01CD	01CE	01CF	01D0	01D1	01D2	01D3	01D4	01D5
470	01D6	01D7	01D8	01D9	01DA	01DB	01DC	01DD	01DE	01DF
480	01E0	01E1	01E2	01E3	01E4	01E5	01E6	01E7	01E8	01E9
490	01EA	01EB	01EC	01ED	01EE	01EF	01F0	01F1	01F2	01F3

Decimal/Hexadecimal Table

	0	1	2	3	4	5	6	7	8	9
500	01F4	01F5	01F6	01F7	01F8	01F9	01FA	01FB	01FC	01FD
510	01FE	01FF	0200	0201	0202	0203	0204	0205	0206	0207
520	0208	0209	020A	020B	020C	020D	020E	020F	0210	0211
530	0212	0213	0214	0215	0216	0217	0218	0219	021A	021B
540	021C	021D	021E	021F	0220	0221	0222	0223	0224	0225
550	0226	0227	0228	0229	022A	022B	022C	022D	022E	022F
560	0230	0231	0232	0233	0234	0235	0236	0237	0238	0239
570	023A	023B	023C	023D	023E	023F	0240	0241	0242	0243
580	0244	0245	0246	0247	0248	0249	024A	024B	024C	024D
590	024E	024F	0250	0251	0252	0253	0254	0255	0256	0257
600	0258	0259	025A	025B	025C	025D	025E	025F	0260	0261
610	0262	0263	0264	0265	0266	0267	0268	0269	026A	026B
620	026C	026D	026E	026F	0270	0271	0272	0273	0274	0275
630	0276	0277	0278	0279	027A	027B	027C	027D	027E	027F
640	0280	0281	0282	0283	0284	0285	0286	0287	0288	0289
650	028A	028B	028C	028D	028E	028F	0290	0291	0292	0293
660	0294	0295	0296	0297	0298	0299	029A	029B	029C	029D
670	029E	029F	02A0	02A1	02A2	02A3	02A4	02A5	02A6	02A7
680	02A8	02A9	02AA	02AB	02AC	02AD	02AE	02AF	02B0	02B1
690	02B2	02B3	02B4	02B5	02B6	02B7	02B8	02B9	02BA	02BB
700	02BC	02BD	02BE	02BF	02C0	02C1	02C2	02C3	02C4	02C5
710	02C6	02C7	02C8	02C9	02CA	02CB	02CC	02CD	02CE	02CF
720	02D0	02D1	02D2	02D3	02D4	02D5	02D6	02D7	02D8	02D9
730	02DA	02DB	02DC	02DD	02DE	02DF	02E0	02E1	02E2	02E3
740	02E4	02E5	02E6	02E7	02E8	02E9	02EA	02EB	02EC	02ED
750	02EE	02EF	02F0	02F1	02F2	02F3	02F4	02F5	02F6	02F7
760	02F8	02F9	02FA	02FB	02FC	02FD	02FE	02FF	0300	0301
770	0302	0303	0304	0305	0306	0307	0308	0309	030A	030B
780	030C	030D	030E	030F	0310	0311	0312	0313	0314	0315
790	0316	0317	0318	0319	031A	031B	031C	031D	031E	031F
800	0320	0321	0322	0323	0324	0325	0326	0327	0328	0329
810	032A	032B	032C	032D	032E	032F	0330	0331	0332	0333
820	0334	0335	0336	0337	0338	0339	033A	033B	033C	033D
830	033E	033F	0340	0341	0342	0343	0344	0345	0346	0347
840	0348	0349	034A	034B	034C	034D	034E	034F	0350	0351
850	0352	0353	0354	0355	0356	0357	0358	0359	035A	035B
860	035C	035D	035E	035F	0360	0361	0362	0363	0364	0365
870	0366	0367	0368	0369	036A	036B	036C	036D	036E	036F
880	0370	0371	0372	0373	0374	0375	0376	0377	0378	0379
890	037A	037B	037C	037D	037E	037F	0380	0381	0382	0383
900	0384	0385	0386	0387	0388	0389	038A	038B	038C	038D
910	038E	038F	0390	0391	0392	0393	0394	0395	0396	0397
920	0398	0399	039A	039B	039C	039D	039E	039F	03A0	03A1
930	03A2	03A3	03A4	03A5	03A6	03A7	03A8	03A9	03AA	03AB
940	03AC	03AD	03AE	03AF	03B0	03B1	03B2	03B3	03B4	03B5
950	03B6	03B7	03B8	03B9	03BA	03BB	03BC	03BD	03BE	03BF
960	03C0	03C1	03C2	03C3	03C4	03C5	03C6	03C7	03C8	03C9
970	03CA	03CB	03CC	03CD	03CE	03CF	03D0	03D1	03D2	03D3
980	03D4	03D5	03D6	03D7	03D8	03D9	03DA	03DB	03DC	03DD
990	03DE	03DF	03E0	03E1	03E2	03E3	03E4	03E5	03E6	03E7

Decimal/Hexadecimal Table

	0	1	2	3	4	5	6	7	8	9
1000	03E8	03E9	03EA	03EB	03EC	03ED	03EE	03EF	03F0	03F1
1010	03F2	03F3	03F4	03F5	03F6	03F7	03F8	03F9	03FA	03FB
1020	03FC	03FD	03FE	03FF	0400	0401	0402	0403	0404	0405
1030	0406	0407	0408	0409	040A	040B	040C	040D	040E	040F
1040	0410	0411	0412	0413	0414	0415	0416	0417	0418	0419
1050	041A	041B	041C	041D	041E	041F	0420	0421	0422	0423
1060	0424	0425	0426	0427	0428	0429	042A	042B	042C	042D
1070	042E	042F	0430	0431	0432	0433	0434	0435	0436	0437
1080	0438	0439	043A	043B	043C	043D	043E	043F	0440	0441
1090	0442	0443	0444	0445	0446	0447	0448	0449	044A	044B
1100	044C	044D	044E	044F	0450	0451	0452	0453	0454	0455
1110	0456	0457	0458	0459	045A	045B	045C	045D	045E	045E
1120	0460	0461	0462	0463	0464	0465	0466	0467	0468	0469
1130	046A	046B	046C	046D	046E	046F	0470	0471	0472	0473
1140	0474	0475	0476	0477	0478	0479	047A	047B	047C	047D
1150	047E	047F	0480	0481	0482	0483	0484	0485	0486	0487
1160	0488	0489	048A	048B	048C	048D	048E	048F	0490	0491
1170	0492	0493	0494	0495	0496	0497	0498	0499	049A	049B
1180	049C	049D	049E	049F	04A0	04A1	04A2	04A3	04A4	04A5
1190	04A6	04A7	04A8	04A9	04AA	04AB	04AC	04AD	04AE	04AF
1200	04B0	04B1	04B2	04B3	04B4	04B5	04B6	04B7	04B8	04B9
1210	04BA	04BB	04BC	04BD	04BE	04BF	04C0	04C1	04C2	04C3
1220	04C4	04C5	04C6	04C7	04C8	04C9	04CA	04CB	04CC	04CD
1230	04CE	04CF	04D0	04D1	04D2	04D3	04D4	04D5	04D6	04D7
1240	04D8	04D9	04DA	04DB	04DC	04DD	04DE	04DF	04E0	04E1
1250	04E2	04E3	04E4	04E5	04E6	04E7	04E8	04E9	04EA	04EB
1260	04EC	04ED	04EE	04EF	04F0	04F1	04F2	04F3	04F4	04F5
1270	04F6	04F7	04F8	04F9	04FA	04FB	04FC	04FD	04FE	04FF
1280	0500	0501	0502	0503	0504	0505	0506	0507	0508	0509
1290	050A	050B	050C	050D	050E	050F	0510	0511	0512	0513
1300	0514	0515	0516	0517	0518	0519	051A	051B	051C	051D
1310	051E	051F	0520	0521	0522	0523	0524	0556	0526	0527
1320	0528	0529	052A	052B	052C	052D	052E	052E	0530	0531
1330	0532	0533	0534	0535	0536	0537	0538	0539	053A	053B
1340	053C	053D	053E	053F	0540	0541	0542	0543	0544	0545
1350	0546	0547	0548	0549	054A	054B	054C	054D	054E	054F
1360	0550	0551	0552	0553	0554	0555	0556	0557	0558	0559
1370	055A	055B	055C	055D	055E	055F	0560	0561	0562	0563
1380	0564	0565	0566	0567	0568	0569	056A	056B	056C	056D
1390	056E	056F	0570	0571	0572	0573	0574	0575	0576	0577
1400	0578	0579	057A	057B	057C	057D	057E	057F	0580	0581
1410	0582	0583	0584	0585	0586	0587	0588	0589	058A	058B
1420	058C	058D	058E	058F	0590	0591	0592	0593	0594	0595
1430	0596	0597	0598	0599	059A	059B	059C	059D	059E	059F
1440	05A0	05A1	05A2	05A3	05A4	05A5	05A6	05A7	05A8	05A9
1450	05AA	05AB	05AC	05AD	05AE	05AF	05B0	05B1	05B2	05B3
1460	05B4	05B5	05B6	05B7	05B8	05B9	05BA	05BB	05BC	05BD
1470	05BE	05BF	05C0	05C1	05C2	05C3	05C4	05C5	05C6	05C7
1480	05C8	05C9	05CA	05CB	05CC	05CD	05CE	05CF	05D0	05D1
1490	05D2	05D3	05D4	05D5	05D6	05D7	05D8	05D9	05DA	05DB

ISS.	MODIFICATION	ECN No.	DATE	DRAWN	CHK'D
1	First issue of HA463561U001, replacing Issue 1 of HA463561. Includes 605C and 590+ Series information.	13424 13967	18/1/00	CM	KJ
2	Updated to include 690+ product	16962	6/08/02	CM	KJ
FIRST USED ON		MODIFICATION RECORD Profibus-DP Communications Interface			
 EUROTHERM DRIVES		DRAWING NUMBER ZZ463561U001			SHT. 1 OF 1

